

TAMLITE[®]

L I G H T I N G

ISSUE 02





RSPLED SERIES
 More info on page 32



ISSUE 02

CES BRANCH USE ONLY

CONTENTS

A Message From Our TamLite Product Managers	4
TAMCO Manufacturing	6-7
TamLite Lighting Facilities	8-9
BAA Compliant	10-13
DLC Listed Products	14-17
2023 Line Card	18
Residential Product Guide	19
Emergency Lighting Guide	20
Low Maintenance Fixtures	21
OSI Sensor Option	22
High Bay Help Sheet	23
HORLED High Bay	24
TAHLED Series	25
CTAMUFO-CSWS Series	26
SLWLED Series Honeycomb Layout	27
CNCFLED Series	28
CWLLED Series	29
STVLED Series	30
TAMGRIP Series	31
RSPLED Series	32-33
Architectural Up/Down Light	34
Backlit Panel Light BLP-CSWS Series	35
LED Frame Light TFL Series	36
Can & Trim Compatibility	37-44
New Gen CCT Selectable LED Retrofit	45
New Gen CH Series	46
JBD6-CS Series	47
All-In-One Hanger Bracket Rough Series	48
TRRMUC Series	49
TRRPL Series	50
TLVC Series Dimmer/Driver In One	51
TRRRT RGBW 24V	52-53
TRRRT & TRRRL Series	54-55
CHRG Series Yoke Mount Included	56
RGBW Floodlight	57
BLST Series Bullet Flood	58
SHN Series Wall Cylinder	59
Outdoor Security Lights	60
DDSLEDWSCS Dusk-to-Dawn	61
STRK Series LED/Area Flood Light	62
Spoke Brackets	63
W2LEDWSCS LED Wall Pack Series	64
MWPWSCS Mini Wall Pack	65
New Gen ESRD	66
LXP Series	67
LXPC-CS Series	68
MSR Series	69
LC-WL Series	70-71



A message from our Product Managers for Tamlite Lighting USA

Hello CES family,

Welcome to the second edition of our Tamlite Lighting Magazine. Inside, you will find our recently updated line card, as of July 2023, including a wide-range collection of product-specific sales flyers. These informative flyers were released throughout last year and highlight some new and exciting products from Tamlite Lighting. Some other tools you will find inside will be a helpful DLC product guide, product compatibility sheets, and information regarding our Made in America lighting products.

2023 has been another incredible and exciting year for Tamlite Lighting. Several new products were launched, and a few product generations were updated to reflect current market requirements. Here recently, we just wrapped up the 2nd annual Projects Conference here at Tamco with great success! Tamlite Lighting even had its first live webinar, now available on CESU.

Our Tamlite Lighting Team has currently grown to six members and they are all working diligently to provide top-tier service to CES. This team is the backbone of our success! They handle everything from technical support to product development. We are thrilled to have such a talented and motivated team to help push the brand forward on a daily basis.

From the entire Tamlite Lighting Team, we want to thank you for your support over the past year! We all look forward to growing our business together, as well as our relationship.

Sincerely,

James Bell
Shawn Cates

-Product Managers for Tamlite Lighting USA

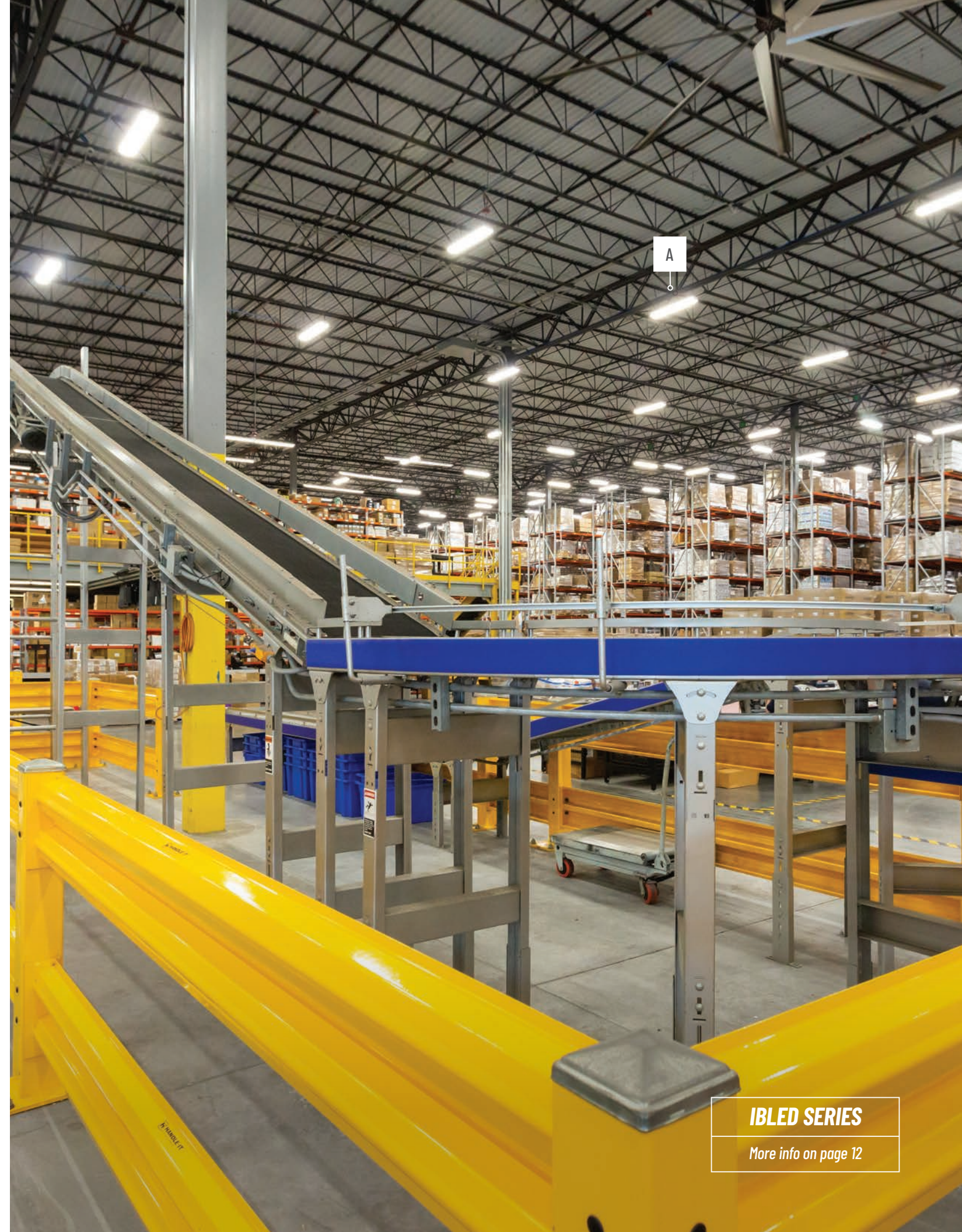

IBLED SERIES

More info on page 12



"DID YOU KNOW?"

MANUFACTURING

If you haven't seen the factory since our grand opening, TAMCO has not stopped firing on all cylinders since. The Production Department is no exception to this. We are dedicated to providing unique solutions via in-house, American-made options.

By leveraging in-house Engineering, and Quality Control departments, TAMCO's Production department manufactures quality lighting and electrical goods exclusively for City Electric Supply, ensuring you're never without options.

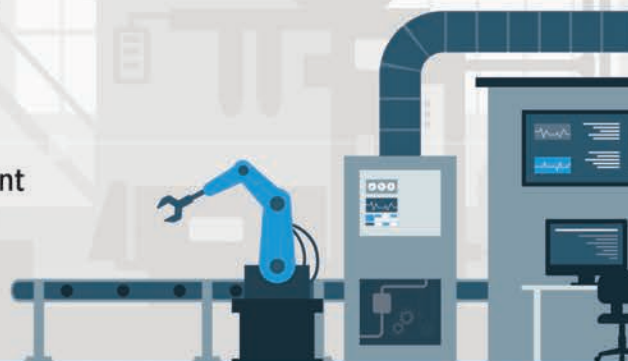

A few of the benefits of using your in-house manufacturing option:



- TAMCO manufactures a broad lighting product range, complete with site-ready configurations to help give your customer exactly what they need.
- Our in-house brand of manufacturing maintains tight quality standards on raw materials - from LED drivers to coils of steel. Quality standards require 100% of fixtures to be tested for functionality prior to shipping, and all steel coils used in manufacturing come with a certification of conformity to ensure only quality goods make it to your branch.
- By purchasing TAMCO products manufactured by the Production team, you're supporting American jobs and doing your part to keep America's economy growing by supporting other local American-run businesses.
- Our quick color change paint booth takes less time to adjust for custom colors & recycles up to 75% of the wasted power coat. That means quicker custom colors at more affordable prices.



2,268,441
POUNDS OF STEEL



783,150
SCREWS

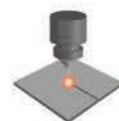

136
MILES TRAVELED ON
THE LASER



110,400,000
LED CHIPS



370
MILES OF WIRE



TAMLITE
LIGHTING

**USA
PROUD**
★★★★★



411,000 sq. ft. manufacturing and fulfillment facility

Presses



Warehouse

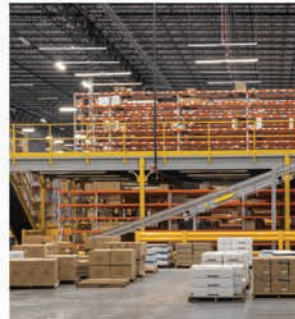

Office



Laser

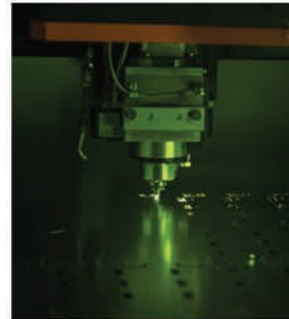

Assembly



QC Lab





MADE IN AMERICA PRODUCTS

Explore a line of TAMCO products proudly made in America.

MADE WITH PRIDE IN THE U.S.A.

STEEL

PAINT

INTERNAL WIRING

LABOR & PACKAGING

 **Steel 24 gauge hot dip galvanized finish**
- Made in SC

 **Paint - Made in Texas.** Architectural type paint designed with superior durability properties.

 **Internal Wiring - GA**

 **Labor & Packaging - FL**

For more information regarding BAA products, please contact Info@Tamliteusa.com.

BAA COMPLIANT PRODUCTS

The following Luminaire families follow the requirements to meet BAA compliance and are manufactured or assembled in Port Saint Lucie, Florida, U.S.A. - which qualifies them for BAA job opportunities.

BAA COMPLIANT



Direct/Indirect Troffers



TC
Fluorescent Commercial Troffer



TCLED
LED Commercial Troffer



TCLEDT
LED Tube Commercial Troffer



STVLED
Volumetric Troffer Direct/Indirect

Surface Mount



LPSM
Light Panel Surface Mount Kit



TLPSM
Flat Panel Surface Mount Kit



WB
Fluorescent Wall/Ceiling Bracket



WBLED
LED Wall/Ceiling Bracket

High Bays



HOLED
High Output Array LED High Bay



HORLED2
2FT LED High Bay



HORLEDT
Full Body LED Tube High Bay



IBLED
I-Beam LED High Bay Gen 2



IBLEDT
LED Tube I-Beam High Bay



IBT
I-Beam Fluorescent High Bay



TAHLED
Spec Grade LED High Bay



BAA COMPLIANT



Wraps



WL
Fluorescent Wraparound



WLSLED
LED Wraparound



WLSLEDT
LED Tube Wraparound

Enclosed and Gasketed



CT
Narrow Enclosed and Gasketed Fluorescent



CTNLED
Narrow Enclosed and Gasketed LED



CTNLEDT
Narrow Enclosed and Gasketed LED Tube



CTWLED
Wide Enclosed and Gasketed LED



CTWLEDT
Enclosed and Gasketed LED Tube

Strip Lights



INDI
Industrial Strip Fluorescent



INDILEDT
Industrial Strip LED Tube



INDS
Slotted Industrial Strip Fluorescent



INDSLEDT
Slotted Industrial Strip LED Tube



SLN
Narrow Fluorescent Strip



SLNLED
Narrow LED Strip



SLNLEDT
Narrow LED Tube Strip



SLW
Wide Fluorescent Strip



SLWLED
Wide LED Strip



SLWLEDT
Wide LED Tube Strip

Architectural



HBLED
Linear LED Direct/Indirect



RSPLED
Versatile Linear Architectural

DLC LISTED PRODUCTS

What a DLC listing means

A DLC listing means that a specific product has been tested to deliver superior energy efficiency. DLC-listed lighting fixtures generally offer higher lumens per watt (LPW). The higher the LPW, the more energy is converted into usable light (and less energy is lost to heat and other inefficiencies).

Did you know our TAMCO Photometric Laboratory in Port St. Lucie, Florida, is an accredited laboratory? This means that we can perform our testing in-house, saving time and money, which passes on to our customers!

Please consult the DLC QPL for a full list of our DLC Compliant products.



RECESSED TROFFER

STVLED Series

Single Channel LED Volumetric

Sizes: 1x4, 2x2, 2x4

Color Temperature: 3500K, 4000K, 5000K

Factory Installed Emergency Back Up Available

STANDARD



LED PANELS

BLP Series

Back-Lit, Single CCT & Wattage

Sizes: 1x4, 2x2, 2x4

Color Temperature: 3500K, 4000K, 5000K

Factory Installed Emergency Back Up Available

PREMIUM



DLC LISTED PRODUCTS

Please consult the DLC QPL for a full list of our DLC Compliant products.



LED PANELS

BLP-CSWS Series

Back-Lit, CCT & Wattage Selectable

Sizes: 1x4, 2x2, 2x4

Wattage Selections:
DIM 1x4 - 25W/30W/36W
DIM 2x2 - 25W/30W/36W
DIM 2x4 - 40W/45W/50W

DIM2 2x2 - 30W/35W/40W
DIM2 2x4 - 30W/40W/50W

Color Selections: 3500K/4000K/5000K

Factory Installed Emergency Back Up Available

STANDARD



HIGHBAYS

IBLED Series

Linear, Wide Distribution

Sizes: 2FT, 4FT

Color Temperature: 4000K, 5000K

Factory Installed Occupancy Sensor and Emergency Back Up Available

STANDARD



HIGHBAYS

TAMHLX*M Series

Linear, Matte Lens

Sizes: 2FT, 4FT

Color Temperature: 5000K

Factory Installed Occupancy Sensor Available

PREMIUM



CTAMUFOCSWS Series

Round, UFO Highbay, CCT & Wattage Selectable

Wattage Selections:
150W - 80W/110W/150W
240W - 180W/200W/240W

Color Selections: 4000K/5000K

Optional Accessories: Microwave Sensor, PIR Sensor, and Wireguard

Optional Mounting Kits: Yoke, Hook, and NPT Mounting

PREMIUM



STRIP LIGHTS

SLWLED Series

Linear Wide Striplight

Sizes: 2FT, 4FT, 8FT

Color Temperature: 3000K, 4000K, 5000K

Factory Installed Occupancy Sensor and Emergency Back Up Available

STANDARD



CTNLED Series

Enclosed and Gasketed LED

Sizes: 2FT, 4FT, 8FT

Color Temperature: 3000K, 4000K, 5000K

Factory Installed Occupancy Sensor and Emergency Back Up Available

STANDARD



DLC LISTED PRODUCTS

Please consult the DLC QPL for a full list of our DLC Compliant products.



OUTDOOR WALLPACKS

W1LEDWSCS Series

Wall Pack, CCT & Wattage Selectable

Wattage Selection: 10W/20W/30W

Color Selections:
3000K/4000K/5000K

Integrated Photocell

STANDARD



W2LEDWSCS Series

Wall Pack, CCT & Wattage Selectable

Wattage Selection: 50W/60W/80W

Color Selections:
3000K/4000K/5000K

Integrated Photocell

STANDARD



W3LEDWSCS Series

Wall Pack, CCT & Wattage Selectable

Wattage Selection: 80W/100W/120W

Color Selections:
3000K/4000K/5000K

Integrated Photocell

STANDARD



W2LED Series

Wall Pack, Single CCT & Wattage

Wattages: 50W, 60W, 80W

Color Temperature: 4000K, 5000K

Factory Installed Emergency Back
Up Available

PREMIUM



CYCLEDSC Series

Cyclops Wall Pack, CCT Selectable

Color Selections:
3000K/4000K/5000K

Integrated Photocell

STANDARD



DLC LISTED PRODUCTS

Please consult the DLC QPL for a full list of our DLC Compliant products.



OUTDOOR FLOODLIGHTING

STRK Series

Versatile LED Area/Flood Light

Wattages: 80W, 150W, 230W, 300W,
400W

Color Temperature: 3000K, 4000K,
5000K

Mounting Options: Square Pole,
Round Pole, Slipfitter, and
Trunnion Mount

PREMIUM



DDSLEDWSCS Series

Dusk to Dawn Security Light, CCT &
Wattage Selectable

Wattage Selection: 30W/40W/50W

Color Selections:
3000K/4000K/5000K

Integrated Photocell

PREMIUM



SPLWS Series

Sports Light, Wattage Selectable

Wattage Selection:
300W/400W/500W

Color Temperature: 5000K

PREMIUM



CHRGWSCS Series

Flood Light, CCT & Wattage
Selectable

Color Selections:
3000K/4000K/5000K

Wattage Selections:
25W - 10W/15W/25W
60W - 30W/50W/60W
80W - 40W/60W/80W

Mounting Options: Yoke and
Knuckle Mount

Integrated Photocell

PREMIUM



OUTDOOR BOLLARD

MPFLED Series

Flood Light, Wattage Selectable

Wattage Selection:
50W/80W/100W/150W

Color Temperature: 5000K

Mounting Options: Yoke, Knuckle,
Trunnion, and Slipfitter

PREMIUM



BOLWSCS Series

Dome Top Bollard, CCT & Wattage
Selectable

Wattage Selection: 14W/19W/24W

Color Selections:
3000K/4000K/5000K

PREMIUM





Full Range of Lighting Products

At TamLite Lighting, we design, manufacture, and source an extensive range of lighting products suitable for a variety of applications, including retail, institutional, hospitality, residential, and industrial spaces. To see our full product offerings, check out our website - WWW.TAMLITEUSA.COM

SCAN THE QR CODE TO DOWNLOAD THE LINE CARD!

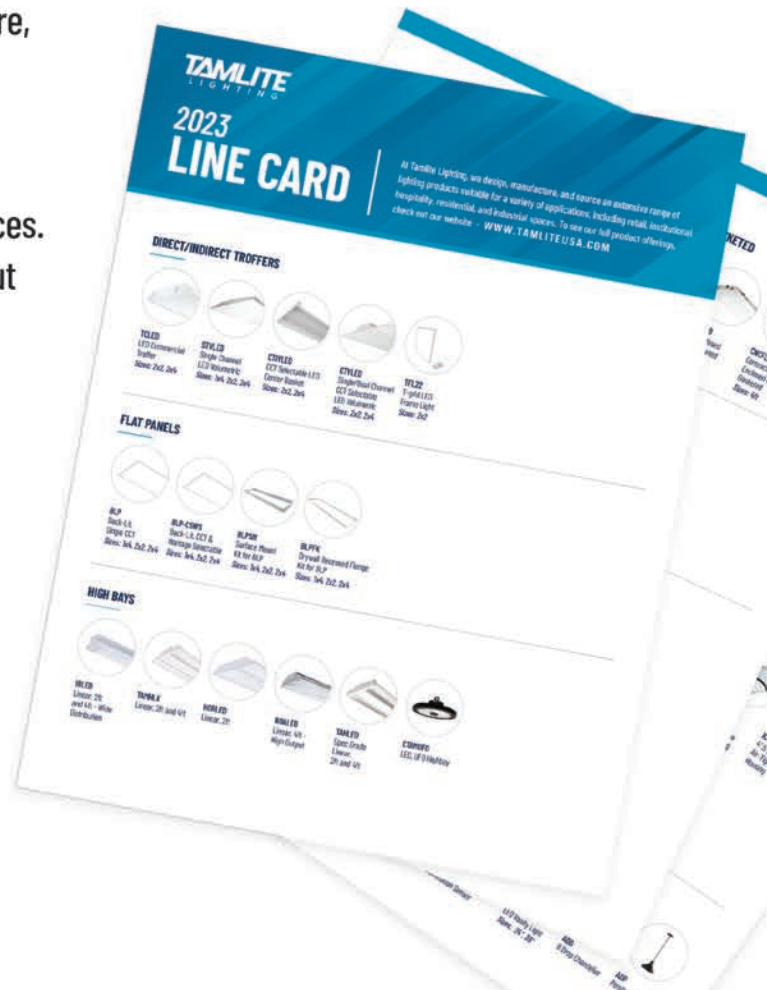

Solutions For Your Home

Get lighting solutions from TamLite Lighting & Fusion Lamps. Addvent has a range of bath fans & door chimes. RPP & Centaur provide electrical solutions for your home, and F4P has all the tools and chemicals you need.

SCAN THE QR CODE TO DOWNLOAD THE CATALOG!

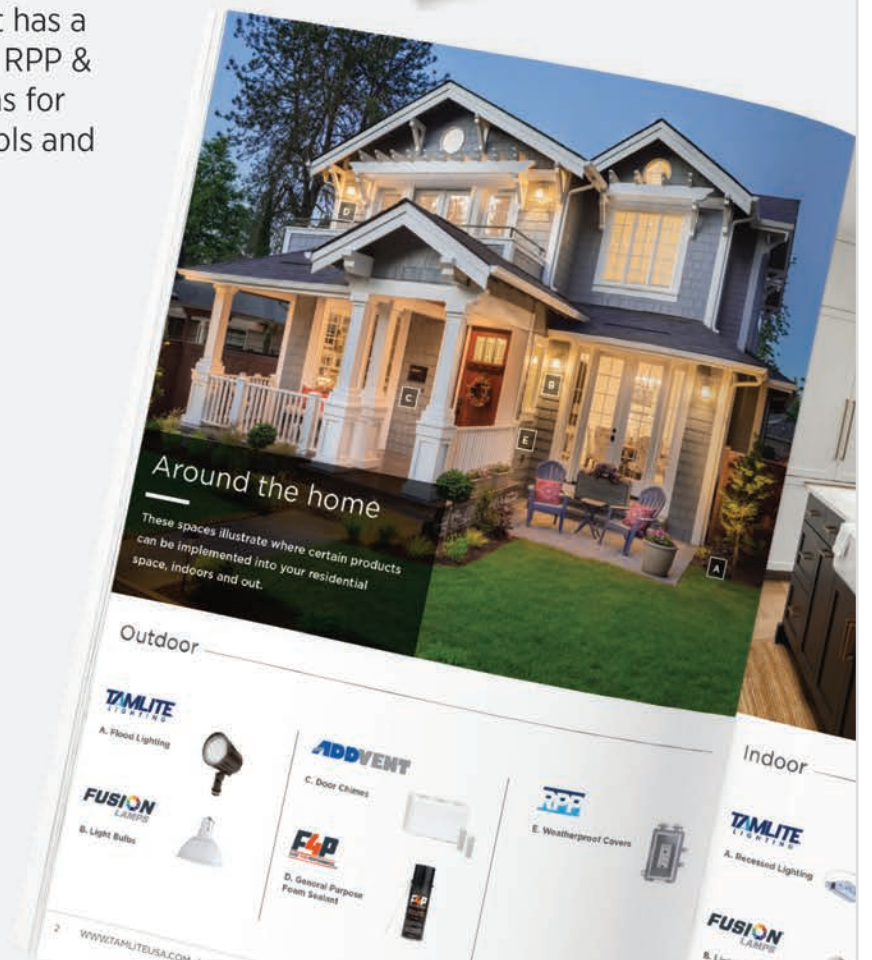

EMERGENCY LIGHTING GUIDE

EXIT
COLLATERAL DOWNLOAD



Emergency Lighting Guide

Emergency lighting and exit signage are integral to the safety and well-being of building occupants. TamLite Lighting provides emergency lights that are designed to illuminate facilities in the event of power failure. Download the catalog to explore a range of emergency lighting, exit signs, emergency and exit combos, remote capable, emergency ballasts, inverters, and more!

SCAN THE QR CODE TO DOWNLOAD THE CATALOG!



SAVE TIME & MONEY

LED Tube ready fixtures are the perfect low-maintenance product for your contractors

Low Maintenance Fixtures

These fixtures offer the flexibility of having LED tubes pre-installed at the factory.* Plus, get the added convenience of replacing the tubes without having to replace the fixture.



*Ask factory for details.



TAMLITE
LIGHTING

SLNLED & SLWLED
LED Strip Light Narrow & Wide



OSI Occupancy Sensor Option

- Available on select lumen packages
- Programmable via optional remote
Remote Stock Code: 0606-9666

Example Part #: SLNLED4-40D101L840-OSI

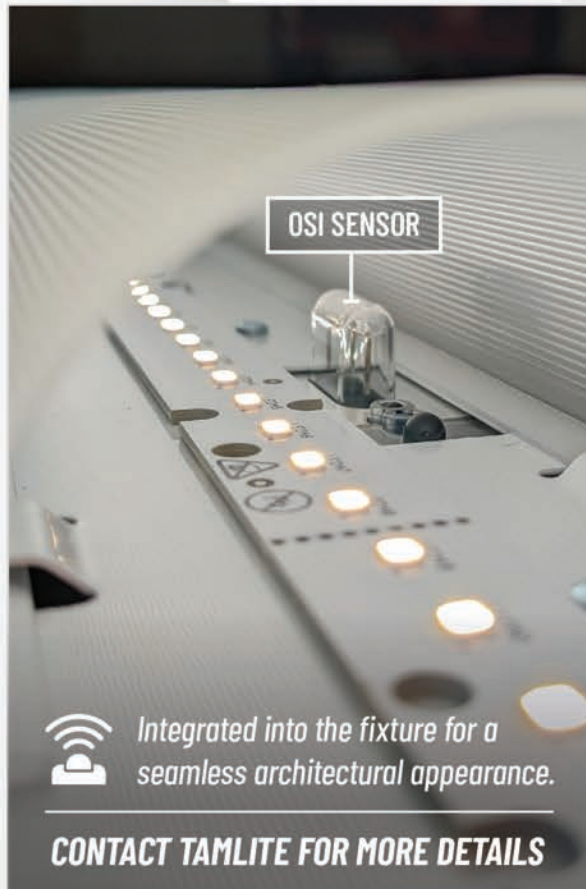

11675 SW TOM MACKIE BLVD. | PORT ST. LUCIE, FL 34987 | PH: 772.878.4944 | TAMLITEUSA.COM

LED HIGH BAY | HELP SHEET



	IBLED					HORLED2				TAMHLX			
Focus													
Stock	**					**				***			
Project	***					***				***			
Mounting													
Surface	Y					Y				Y			
Suspended	Y					Y				Y			
Pendant	Y					Y				Y			
Sizes	4ft - Linear					2x2				-			
Features & Performance													
Wattage	75	150	200	225	375	100	150	200	300	110	165	220	300
Lumens	10,000	15,000/ 17,500/ 20,000	25,000	30,000	50,000	13,000	20,000	27,000	37,000	13,000	20,000	27,000	36,500
CCT	35K, 4K, 5K					35K, 4K, 5K				5K			
DLC	Y					N				Y			
NSF	N					N				N			
BAA	Y					Y				N			
EMB	Factory Install					Factory Install				Factory Install			
OS Sensor	Factory Install					Factory Install				Factory Install			
Wire Guard	Y					N				N			

	CTAMUFO					TAHLED				HORLEDT			
Focus													
Stock	***					-				***			
Project	***					***				*			
Mounting													
Surface	Y					Y				Y			
Suspended	Y					Y				Y			
Pendant	Y					Y				Y			
Sizes	Round					2ft, 4ft- Linear				4ft- Linear			
Features & Performance													
Wattage	100	150	200	240	80	135	155	200	18W LED TUBE				
Lumens	13,200	20,000	26,240	30,975	13,000	20,000	24,000	34,000	8,800	13,200	19,800	28,600	
CCT	5K					4K, 5K				35K, 4K, 5K			
DLC	Y					N				N			
NSF	N					N				N			
BAA	N					Y				Y			
EMB	Field Install					Factory Install				Factory Install			
OS Sensor	Field Install					Factory Install				Factory Install			
Wire Guard	N					N				Y			

* Good ** Better *** Best

MADE IN THE USA HORLED HIGH BAY

HORLED SERIES

The HORLED is Made in the USA and better than ever.

- ★ Higher lumens per watt
- ★ Occupancy sensor available
- ★ Emergency backup available

Features:

- Up to 133 lm/W with lens, 157 lm/W without lens
- Removable lens
- Dimmable
- 50,000-hour life
- Aircraft cable included
- 120-277V



EXAMPLE: HORLED2-130D20L840

SERIES	LUMEN OUTPUT*	LENS	CRI	COLOR TEMP.	OPTIONS
HORLED2	[-130D2]: 13,000lm [-200D2]: 20,000lm [-270D2]: 27,000lm [-370D4]: 37,000lm [-500D4]: 50,000lm	[0]: Opaque	[L8]: CRI±80	[40]: 4000K [50]: 5000K	[BLANK]: No Options [-OS]: Internal Microwave Sensor** [-W6-3]: Flex Whip 6 3 Wire*** [EM]: 10% EM Light Output

*Higher lumen available upon request.

**See settings below.

***More options available. Please contact factory for more details.

For 480v option, please contact factory.



TAHLED SERIES

The TAHLED series high bay is a high-temp, high-output aluminum high bay with premium features and BAA compliance.



EXAMPLE: TAHLED2-130D1L840BK

SERIES	SIZE & LUMEN OUTPUT	CRI	COLOR TEMP.	OPTIONS	EMERGENCY	FINISH
[TAHLED2] - 2ft	[-130D1]: 13,000Lm [-200D2]: 20,000Lm [-240D2]: 24,000Lm [-370D2]: 37,000Lm	[L8]: CRI±85	[40]: 4000K [50]: 5000K	[HT]: High Temp** [OS]: Microwave Sensor [W6-3]: Flex Whip-6 3 Wire**** [WC6-515]: Cord-6S-J-515 Plug*****	[BLANK]: None [-EM]: 10% Light Output***	[Blank]: White [BK]: Black* [GY]: Grey* [RAL]: Custom Color*
[TAHLED4] - 4ft	[-130D1]: 13,000Lm [-200D2]: 20,000Lm [-360D4]: 36,000Lm [-400D4]: 40,000Lm					

*MOQ Required- Please contact factory for details.

**Ambient Temperature rating of 122°F.

***Emergency Backup - Available only on fixtures up to 40,000 lumens.

****Additional whip, cord, and plug configurations available. Please consult factory.

Higher Lumen and High Temperature options available upon request - Please contact factory for details.



CCT/Wattage Selectable High Bay CTAMUFO-CSWS

FIELD ADJUSTABLE



TAMLITE LIGHTING

Upgraded features & performance!

Reduce your SKU's and INCREASE your selling power! The newly re-designed CTAMUFO series offers new selectable features and an optional sensor.

This unit is designed with selector switches for Wattage and Color Temperature.

WATTAGE SELECTABLE

150W - 80W/110W/150W
240W - 180W/200W/240W

Color Selectable between 4000K and 5000K

EXAMPLE: CTAMUFO150W-CSWS

SERIES	WATTAGE & CCT (SELECTABLE)	OPTIONS
[CTAMUFO]	[150W-CSWS]: 80W/110W/150W - 4000K/5000K	[Blank]: Black housing [-WH]: White housing
	[240W-CSWS]: 180W/200W/240W - 4000K/5000K	

*These units can not be connected to a dimming device when it's equipped with a Motion Sensor.
*No emergency backup available.



Accessories



CTAMUFO-SENSOR-MW • 0582-9393
MICROWAVE SENSOR FOR CTAMUFO-CSWS

CTAMUFO-SENSOR-PIR • 0588-0699
PIR SENSOR FOR CTAMUFO-CSWS



CTAMUFO-REMOTE • 0582-9405
REMOTE FOR CTAMUFO-CSWS SENSORS



CTAMUFO150W-LENS • 0587-3268
REFLECTOR FOR 150W CSWS UFO

CTAMUFO240W-LENS • 0587-3265
REFLECTOR FOR 240W CSWS UFO



CTAMUFO150W-WG • 0582-7014
WIRE GUARD FOR 150W CSWS UFO

CTAMUFO240W-WG • 0582-7017
WIRE GUARD FOR 240W CSWS UFO



CTAMUFOCSWS-NPT.5 • 0629-1813
1/2" NPT Adapter for CTAMUFO-CSWS

CTAMUFOCSWS-NPT.75 • 0582-9657
3/4" NPT Adapter for CTAMUFO-CSWS



CTAMUFO-YOKE100150 • 0554-4723
YOKE MOUNT FOR 150W MODEL

CTAMUFO-YOKE200240 • 0554-4726
YOKE MOUNT FOR 240W MODEL



CTAMUFOCSWS-HOOK • 0587-5974
HOOK MOUNT FOR CTAMUFO-CSWS



Location: TAMCO Corporate Office
Fixture Used: SLWLED Series
Fixture Layout: Custom Honeycomb Layout

SLWLED SERIES CUSTOM HONEYCOMB LAYOUT

Wire Way Specific Fixture

The SLWLED wide strip series is suitable for general purpose lighting in a wide variety of environments, such as commercial, industrial, retail, or warehouse lighting applications.

This fixture can be installed in a unique honeycomb grid pattern, which will add visual lighting interest to your space.



AVAILABLE IN 4' AND 8' OPTIONS



LIGHT THE WAY, NO MATTER THE CONDITIONS WITH OUR CNCFLED



CNCFLED SERIES

The CNCF series is suitable for environments where humidity and moisture are present. The enclosed and gasketed design make it ideal for wet locations, such as open parking garages, open stairwells, and refrigerated areas.

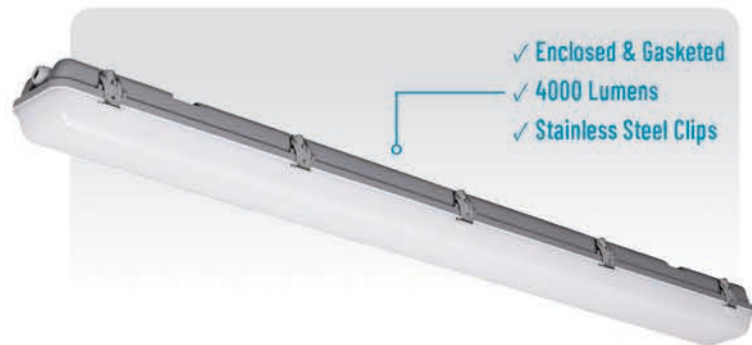

PART NUMBER	STOCK CODE	LENGTH	COLOR TEMP
CNCFLED4-40D1L840	0485-6331	4'	4000K
CNCFLED4-40D1L850	0485-6334	4'	5000K

CONTRACTOR SERIES WRAP LIGHT

VERSATILE AND STYLISH FINISH

CWLED SERIES

The CWLED series LED Wraparound offers an affordable solution to a wide variety of commercial, industrial, or retail lighting applications. This fixture utilizes an extruded polycarbonate lens for dependable performance and soft, even lighting. This fixture is intended for surface mounted applications.

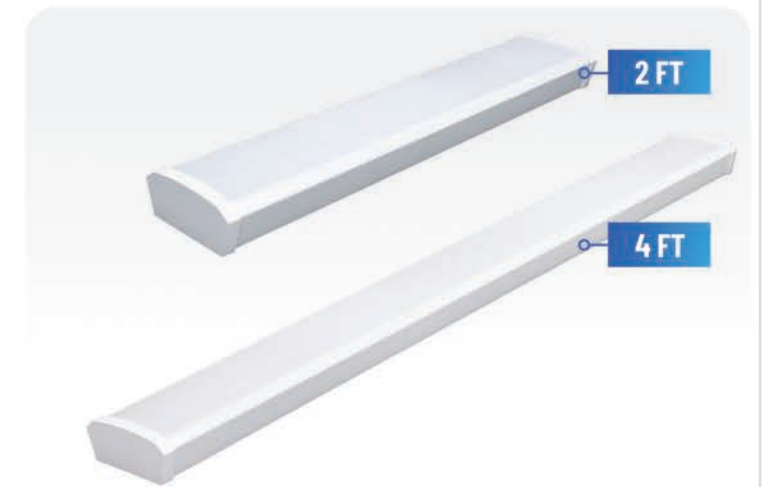

PART NUMBER	STOCK CODE	DESCRIPTION
CWLED2-20D1L840	0474-0315	2FT 2000LM 4K CONTRACTOR WRAP
CWLED2-20D1L850	0474-0318	2FT 2000LM 5K CONTRACTOR WRAP
CWLED4-32D1L840	0453-6282	4FT 3200LM 4K CONTRACTOR WRAP
CWLED4-32D1L850	0453-6285	4FT 3200LM 5K CONTRACTOR WRAP

INTRODUCING STVLED SERIES

The STVLED series is a slim volumetric direct/indirect troffer with a center light channel providing quality light with modern styling and high visual comfort.



STVLED SERIES

Features

- Slim profile
- BAA Compliant
- Damp location rated
- Made in USA
- DLC Listed



Ordering matrix

Example: STVLED14-40D1L840

Series	Size	Lumen Output	Number Of Drivers	CRI	Color Temp	Options	Finish	Emergency
STVLED	[14]: 1 x 4'	[40]: 4000lm	[01]: 1 Driver	[8]: CRI+/-85	[35]: 3500K	[WC6-515]: Cord- 6'SJ-515 Straight Plug	[Blank]: White [BK]: Black	[EM]: 10% Emergency Output
	[22]: 2' x 2'	[60]: 6000lm			[40]: 4000K			
	[24]: 2' x 4'	[80]: 8000lm (8000lm only offered in 2'x4')			[50]: 5000K			

TAMGRIP SERIES SUSPENSION CABLES & KITS



Suspension cables & kits provide quick installation solutions offering a sleek, professional, and discreet finish without compromising on strength and safety.

TAMGRIP SERIES

The TAMGRIP series applications include warehouses, industrial facilities, conference rooms, reception areas, retail, and where suspension wire mounting is required.



TAMGRIP-10FT-KIT
ALL IN ONE, 10FT HANGER KIT
0553-3296



TAMGRIP-10FT-Y-TOG
10FT HANGER, Y SPLITTER
DOUBLE TOGGLE
0553-3305



TAMGRIP-10FT-LOOP
10FT SUSPENSION CABLE,
LOOP END, GRIPPER
0581-8029



TAMGRIP-SLIDE LOCK
CABLE SLIDE LOCK (GRIPPER)
0581-8035



TAMGRIP-20FT-LOOP
20FT SUSPENSION CABLE,
LOOP END, GRIPPER
0582-5034



TAMGRIP-SLIDE LOCK-CLIP
CABLE SLIDE LOCK W/CLASP
0581-8032



INTRODUCING RSPLLED SERIES

The RSPLLED series provides modern aesthetics and high visual comfort to any retail, office space, or restaurant. The RSPLLED can be linked together to form custom layouts, while also delivering excellent and efficient light output.



NEW GENERATION



Available with up-light/down-light



RSPLLED Series: Cable Mounting



RSPLLED Series: Pendant Mounting



RSPLLED Series: Hard-lid & T-Grid Recessed Mounting



RSPLLED Series: Surface/Wall Mounting

RSPLLED Series: Ordering Information

RSPLLED Series: Cable Mounting

Example: RSPLLED24-40D1C01L830

SERIES	SIZE & LUMEN OUTPUT	MOUNTING OPTION	LENS	CRI	COLOR TEMP	OPTIONS	FINISH
RSPLLED	[22-20D1]: 2' x 2' 2000Lm	[C]: Cable Mounted	[Blank]: No Lens	[L8]: CRI+/ -85	[30]: 3000K	[Blank]: No Options	[Blank]: White (Standard)
	[24-40D1]: 2' x 4' 4000Lm		[01]: Acrylic		[35]: 3500K	[-EM]: Emergency Backup	[BK]: Black
	[26-60D1]: 2' x 6' 6000Lm				[40]: 4000K	[U30]: 30% Up Light	[GY]: Grey*
	[28-80D2]: 2' x 8' 8000Lm				[50]: 5000K	[U50]: 50% Up Light	[EG]: Custom Engraving*
						[U100]: 100% Up Light	[HD]: Hydro-Dipped*
							[CC]: Custom Color*

*MOQ Required- Please contact factory for details.

RSPLLED Series: Pendant Mounting

Example: RSPLLED28-80D2P01L830

SERIES	SIZE & LUMEN OUTPUT	MOUNTING OPTION	LENS	CRI	COLOR TEMP	OPTIONS	FINISH
RSPLLED	[22-20D1]: 2' x 2' 2000Lm	[P]: Pendant Mounted	[Blank]: No Lens	[L8]: CRI+/ -85	[30]: 3000K	[Blank]: No Options	[Blank]: White (Standard)
	[24-40D1]: 2' x 4' 4000Lm		[01]: Acrylic		[35]: 3500K	[-EM]: Emergency Backup	[BK]: Black
	[26-60D1]: 2' x 6' 6000Lm				[40]: 4000K	[U30]: 30% Up Light	[GY]: Grey*
	[28-80D2]: 2' x 8' 8000Lm				[50]: 5000K	[U50]: 50% Up Light	[EG]: Custom Engraving*
						[U100]: 100% Up Light	[HD]: Hydro-Dipped*
							[CC]: Custom Color*

*MOQ Required- Please contact factory for details.

RSPLLED Series: Hard-lid & T-Grid Recessed Mounting

Example: RSPLLED24-40D1R01L830

SERIES	SIZE & LUMEN OUTPUT	MOUNTING OPTION	LENS	CRI	COLOR TEMP	OPTIONS	FINISH
RSPLLED	[22-20D1]: 2' x 2' 2000Lm	[R]: Recessed Hard-lid Mounted	[Blank]: No Lens	[L8]: CRI+/ -85	[30]: 3000K	[Blank]: No Options	[Blank]: White (Standard)
	[24-40D1]: 2' x 4' 4000Lm	[G]: Recessed Grid Mounted	[01]: Acrylic		[35]: 3500K	[-EM]: Emergency Backup	[BK]: Black
	[26-60D1]: 2' x 6' 6000Lm				[40]: 4000K		[GY]: Grey*
	[28-80D2]: 2' x 8' 8000Lm				[50]: 5000K		[EG]: Custom Engraving*
							[HD]: Hydro-Dipped*
							[CC]: Custom Color*

*MOQ Required- Please contact factory for details.

Joiner/angle brackets and other custom layouts available by contacting our Quotes department.

RSPLLED Series: Surface/Wall Mounting

Example: RSPLLED26-60D1W01L830

SERIES	SIZE & LUMEN OUTPUT	MOUNTING OPTION	LENS	CRI	COLOR TEMP	OPTIONS	FINISH
RSPLLED	[22-20D1]: 2' x 2' 2000Lm	[W]: Surface Wall Mounted	[Blank]: No Lens	[L8]: CRI+/ -85	[30]: 3000K	[Blank]: No Options	[Blank]: White (Standard)
	[24-40D1]: 2' x 4' 4000Lm		[01]: Acrylic		[35]: 3500K	[-EM]: Emergency Backup	[BK]: Black
	[26-60D1]: 2' x 6' 6000Lm				[40]: 4000K	[U30]: 30% Up Light	[GY]: Grey*
	[28-80D2]: 2' x 8' 8000Lm				[50]: 5000K	[U50]: 50% Up Light	[EG]: Custom Engraving*
						[U100]: 100% Up Light	[HD]: Hydro-Dipped*
							[CC]: Custom Color*

*MOQ Required- Please contact factory for details.

Joiner/angle brackets and other custom layouts available by contacting our Quotes department.

DESIGN, ILLUMINATE, INSPIRE WITH OUR UPD SERIES



UPDRLED2-40D1L840



UPDLED4-42D1L840

ARCHITECTURAL UP/DOWN LIGHT

The UPD series suspended luminaire is available in a 22" Circular (UPDRLED2) and 7'x4' linear (UPDLED4) style. Utilizing an advanced LED optical system, it achieves evenly distributed lighting in both directions.

APPLICATIONS

These architectural fixtures are designed for applications where accented up lighting is called for while not having to sacrifice your down lighting. Excellent for lobbies, lounges, restaurants, and residential applications.



PART NUMBER	STOCK CODE	DESCRIPTION
UPDRLED2-40D1L840	0538-7793	2FT ROUND UP/DOWN LIGHT 4000LM AT 4K
UPDLED4-42D1L840	0424-7865	4FT LINEAR UP/DOWN LIGHT 4200LM AT 4K

BACKLIT PANEL LIGHT

Color and Wattage Selectable



The Flexibility of the BLP-CSWS Series is what today's Contractor wants

The new back-lit panel units are lighter, brighter, and more efficient than standard edge-lits, while providing the same edge-to-edge light diffusion. **BLP-CSWS is now available with pre-installed emergency backup and is in stock!**



Ordering Info

SERIES	SIZE	COLOR TEMP	WATTAGE	DIMMING	TRIM COLOR		EMERGENCY
					[-W] White Trim (Standard)	[BLANK] : No Option [-EM] : EM BACKUP, 10% LIGHT OUTPUT	
BLP	[14] : 7' x 4'	[-CS] : 35/4K/5K	[WS] : 25/30/36W				
BLP	[22] : 2' x 2'	[-CS] : 35/4K/5K	[WS] : 30/35/40W	[-DIM2] : Dimmable	[-W] White Trim (Standard)		
BLP	[24] : 2' x 4'	[-CS] : 35/4K/5K	[WS] : 30/40/50W				

Mounting Kits

SERIES	SIZE	MOUNTING	EMERGENCY OPTIONS
BLP	[14] : 7' x 4'	[SM] : Surface Mount	[Blank] : No Option [EM] : EM Fixture
	[22] : 2' x 2'		
	[24] : 2' x 4'		
BLP	[14] : 7' x 4'	[FK] : Recessed Flange Kit	[Blank] : No Option
	[22] : 2' x 2'		
	[24] : 2' x 4'		

TFL SERIES

LED FRAME LIGHT

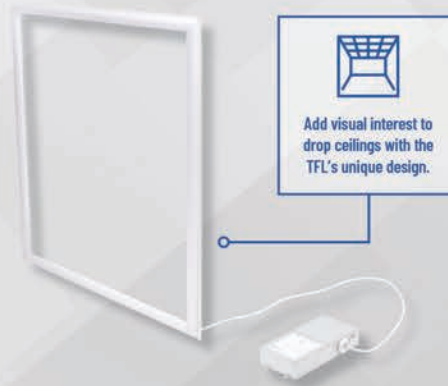
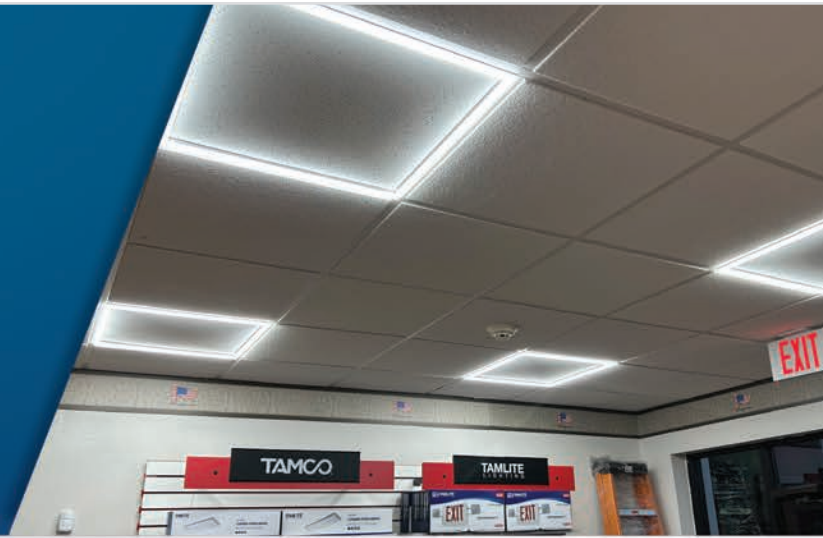

TFL Series Applications

This unique approach to indirect lighting provides a distinctive look to traditionally mundane drop ceilings. When paired with decorative ceiling tiles, the TFL series provides a head-turning look while still offering optimal lighting. Make your next jobsite the talk of the town with TamLite TFL series LED Frame Lights!

SERIES	SIZE	WATTAGE	COLOR TEMP.	DIMMING OPTION
TFL	[22] : 2x2	[-40] : 40W	[40D] : 4000K [50D] : 5000K	[-DIM] : DIMMABLE



CAN & TRIM COMPATIBILITY

EXPLORE A VARIETY OF TRIMS OPTIONS FOR 4", 5", AND 6" CANS.

4" CANS SEE COMPATIBLE CAN & TRIM OPTIONS BELOW.

4" CANS



COMPATIBLE TRIMS FOR 4" CANS (IC104AT, IC104RAT, DL104, DL104R, TRRIC104AT-FR)

(p) indicates plastic option available.

<p>TM24B 4" Baffle Trim IC & Non IC: BR/PAR20 - 50W Max.</p>	<p>TM24C 4" Reflector Trim IC & Non IC: BR/PAR20 - 50W Max.</p>	<p>TM84E 4" Eyeball Trim IC & Non IC: BR/PAR20 - 50W Max.</p>	<p>TM28 4" Adjustable Gimbal Trim IC & Non IC: BR/PAR20 - 50W Max.</p>
<p>TM25B 4" Wall Wash with Baffle IC & Non IC: BR/PAR20 - 50W Max.</p>	<p>TM25C 4" Wall Wash with Reflector IC & Non IC: BR/PAR20 - 50W Max.</p>	<p>TM215 4" Albalite Glass Shower Trim IC & Non IC: BR/PAR20 - 50W Max.</p>	<p>TM217 4" Fresnel Glass Shower Trim IC & Non IC: BR/PAR20 - 50W Max.</p>
<p>TM445 4" Square Gimbal Trim IC & Non IC: BR/PAR20 - 50W Max.</p>	<p>TM4A 4" Full Cone Baffle Trim IC & Non IC: BR/PAR20 - 50W Max.</p>		

5" CANS SEE COMPATIBLE CAN & TRIM OPTIONS BELOW.

5" CANS



COMPATIBLE TRIMS FOR 5" CANS (IC205AT, IC205RAT)

(p) indicates plastic option available.

<p>TM5A 5" Air Tight Cone Baffle (Self Flanged) IC & Non-IC: BR/PAR30 - 75W Max.</p>	<p>TM55 5" Open Trim (Metal) IC & Non-IC: BR/PAR30 - 75W Max.</p>	<p>TM55B 5" Baffle Trim (Metal ring on special finishes) IC & Non-IC: BR/PAR30 - 75W Max.</p>	<p>TM55R 5" Reflector Trim (Metal ring on special finishes) IC & Non-IC: BR/PAR30 - 75W Max.</p>
<p>TM95R 5" Full Cone Reflector Trim IC: BR/PAR30 - 75W / A19 - 40W Max., Non IC: BR/PAR30 - 75W / A19 - 60W Max.</p>	<p>TM853E 5" Deep Eyeball Trim IC & Non-IC: BR/PAR30 - 75W Max.</p>	<p>TM855E 5" Eyeball Trim IC & Non-IC: BR/PAR20 - 75W Max.</p>	<p>TM58 5" Adjustable Flush Gimbal IC: BR/PAR30 - 50W Max., Non IC: BR/PAR30 - 75W Max.</p>
<p>TM513 5" Flat Frosted Shower Trim IC: A19 - 40W Max., Non IC: A19 - 60W Max.</p>	<p>TM57 5" Albalite Glass Shower Trim IC: A19 - 40W Max., Non IC: A19 - 60W Max.</p>	<p>TM53 5" Fresnel Glass Shower Trim IC: A19 - 40W Max., Non IC: A19 - 60W Max.</p>	<p>TM58B 5" Adjustable Regressed Gimbal Trim IC: BR/PAR30 - 50W Max., Non IC: BR/PAR30 - 75W Max.</p>

5" SLOPE



COMPATIBLE TRIMS FOR 5" SLOPE CANS (IC5-SAT, IC5R-SAT)

<p>TM5BS 5" Baffle Sloped Trim IC & Non-IC: PAR30/R30 - 75W Max.</p>	<p>TM5S 5" Baffle Sloped Reflector Trim IC & Non-IC: PAR30/R30 - 75W Max.</p>
---	--

6" CANS SEE COMPATIBLE CAN & TRIM OPTIONS BELOW.

6" CANS



COMPATIBLE TRIMS FOR 6" CANS (IC206ATQ, IC206ATQF, DL106, DL106R, IC206AT, TRRIC206ATQ-FR)











(p) indicates plastic option available.

<p>TM102A 6" Air Tight Cone Baffle (Self Flange/Pre-Installed Gasket) IC: BR40 - 90W / BR/PAR30 - 75W Max., Non-IC: BR40/PAR38 - 100W Max.</p>	<p>TM3 6" Open Trim (Metal) IC & Non-IC: BR/PAR30 - 75W Max.</p>	<p>TM4 6" Open Trim (Metal) Non-IC: BR40/PAR38 - 150W Max.</p>	<p>TM3B 6" Baffle Trim (Metal ring on special finishes) IC & Non-IC: BR/PAR30 - 75W Max.</p>
<p>TM4B 6" Baffle Trim (Metal ring on special finishes) Non-IC: BR40/PAR38 - 150W Max.</p>	<p>TM3R 6" Reflector Trim (Metal ring on special finishes) IC & Non-IC: BR/PAR30 - 75W Max.</p>	<p>TM4R 6" Reflector Trim (Metal ring on special finishes) Non-IC: BR40/PAR38 - 150W Max.</p>	<p>TM19R 6" Reflector Trim IC: A19 - 40W / BR/PAR30 - 75W Max., Non IC: A19/PAR38/R40 - 100W Max.</p>
<p>TM19RA 6" Air Tight Reflector (Metal ring on special finishes) IC: A19 - 40W / BR/PAR30 - 75W Max., Non IC: A19/PAR38/R40 - 100W Max.</p>	<p>TM8E 6" Eyeball with Baffle (All steel construction) IC & Non-IC: BR/PAR30 - 75W Max.</p>	<p>TM38E 6" Eyeball with Baffle (All steel construction) IC & Non-IC: BR/PAR30 - 75W Max.</p>	<p>TM98E 6" Regressed Eyeball (White metal ring) IC & Non-IC: BR/PAR30 - 75W Max.</p>

ADDITIONAL COMPATIBLE TRIMS LISTED ON NEXT PAGE

6" CANS | SEE COMPATIBLE CAN & TRIM OPTIONS BELOW.

COMPATIBLE TRIMS FOR 6" CANS (IC206ATQ, IC206ATQF, DL106, DL106R, IC206AT, TRRIC206ATQ-FR) *(p) indicates plastic option available.

 <p>TM638B 6" Baffle with Regressed Gimbal Ring (Metal ring on special finishes) Non-IC: BR40/PAR38 - 150W Max.</p>	 <p>TM330 6" Gimbal Ring (All steel construction) IC & Non-IC: BR/PAR30 - 75W Max.</p>	 <p>TM338 6" Gimbal Ring (All steel construction) Non-IC: BR40/PAR38 - 150W Max.</p>	 <p>TM54C 6" Wall Wash with Reflector IC: A19 - 40W Max., Non-IC: BR/PAR30 - 75W Max.</p>
 <p>TM54B 6" Wall Wash with Baffle IC: A19 - 40W Max., Non-IC: BR/PAR30 - 75W Max.</p>	 <p>TM102AWT 6" Wet Location Air Tight Shower Baffle (Self-flange) PAR30 - 75W Max. / Outdoor Rated Lamp (ONLY)</p>	 <p>TM13 6" Flat Frosted Shower Trim IC: A19 - 40W Max., Non-IC: A19 - 60W Max.</p>	 <p>TM15(P) 6" Albalite Glass Shower Trim IC: A19 - 40W Max., Non-IC: A19 - 60W Max.</p>
 <p>TM16(P) 6" Drop Opal Glass Shower Trim IC: A19 - 40W Max., Non-IC: A19 - 60W Max.</p>	 <p>TM17(P) 6" Fresnel Glass Shower Trim IC: A19 - 40W Max., Non-IC: A19 - 60W Max.</p>		

6" CANS | SEE COMPATIBLE CAN & TRIM OPTIONS BELOW.

SHALLOW 6" CANS

COMPATIBLE TRIMS FOR SHALLOW 6" CANS (IC406, IC406R, DL406, DL406R) *(p) indicates plastic option available.

			
 <p>TM3 6" Open Trim (Metal) IC & Non-IC: BR/PAR30 - 75W Max.</p>	 <p>TM4 6" Open Trim (Metal) Non-IC: BR40/PAR38 - 150W Max.</p>	 <p>TM3B 6" Baffle Trim (Metal ring on special finishes) IC & Non-IC: BR/PAR30 - 75W Max.</p>	 <p>TM4B 6" Baffle Trim (Metal ring on special finishes) Non-IC: BR40/PAR38 - 150W Max.</p>
 <p>TM3R 6" Reflector Trim (Metal ring on special finishes) IC & Non-IC: BR/PAR30 - 75W Max.</p>	 <p>TM4R 6" Reflector Trim (Metal ring on special finishes) Non-IC: BR40/PAR38 - 150W Max.</p>	 <p>TM8E 6" Eyeball with Baffle (All steel construction) IC & Non-IC: BR/PAR30 - 75W Max.</p>	 <p>TM98E 6" Regressed Eyeball (White metal ring) IC & Non-IC: BR/PAR30 - 75W Max.</p>
 <p>TM638B 6" Baffle with Regressed Gimbal Ring (Metal ring on special finishes) Non-IC: BR40/PAR38 - 150W Max.</p>	 <p>TM330 6" Gimbal Ring (All steel construction) IC & Non-IC: BR/PAR30 - 75W Max.</p>	 <p>TM338 6" Gimbal Ring (All steel construction) Non-IC: BR40/PAR38 - 150W Max.</p>	 <p>TM54C 6" Wall Wash with Reflector IC: A19 - 40W Max., Non-IC: BR/PAR30 - 75W Max.</p>

ADDITIONAL COMPATIBLE TRIMS LISTED ON NEXT PAGE

6" CANS SEE COMPATIBLE CAN & TRIM OPTIONS BELOW.

COMPATIBLE TRIMS FOR SHALLOW 6" CANS (IC406, IC406R, DL406, DL406R)
*(p) indicates plastic option available.



TM54B
6" Wall Wash with Baffle
IC: A19 - 40W Max.,
Non IC: BR/PAR30 - 75W Max.



TM13
6" Flat Frosted Shower Trim
IC: A19 - 40W Max., Non IC: A19 - 60W Max.



TM15(P)
6" Albalite Glass Shower Trim
IC: A19 - 40W Max.,
Non IC: A19 - 60W Max.



TM16(P)
6" Drop Opal Glass Shower Trim
IC: A19 - 40W Max.,
Non IC: A19 - 60W Max.



TM17(P)
6" Fresnel Glass Shower Trim
IC: A19 - 40W Max.,
Non IC: A19 - 60W Max.

6" SLOPE CANS



DL906



DL906R



IC806



IC806R



IC906AT

COMPATIBLE TRIMS FOR 6" SLOPE CANS (DL906, DL906R, IC806, IC806R, IC906AT)
*(p) indicates plastic option available.



TM4BL
6" Slope Baffle
(Metal ring on special finishes)
IC: BR/PAR30 - 75W Max.,
Non IC: BR40/PAR38 - 150W Max.



TM4RL
6" Slope Reflector
(Metal ring on special finishes)
IC: BR/PAR30 - 75W Max.,
Non IC: BR40/PAR38 - 150W Max.



TM8E
6" Eyewall Trim
(All steel construction)
IC & Non-IC: BR/PAR30 - 75W Max.



TM98E
6" Regressed Eyeball
IC & Non-IC: BR/PAR30 - 75W Max.



TM15(P)
6" Albalite Glass Shower Trim
IC: A19 - 40W Max., Non IC: A19 - 60W Max.



TM17(P)
6" Fresnel Glass Shower Trim
IC: A19 - 40W Max., Non IC: A19 - 60W Max.

6" CANS SEE COMPATIBLE CAN & TRIM OPTIONS BELOW.

6" SUPER SLOPE CANS



IC9068AT



DL9068R

COMPATIBLE TRIMS FOR 6" SUPER SLOPE CANS (IC9068AT, DL9068R)
*(p) indicates plastic option available.



TM48BL
6" Super Slope Baffle
IC: BR/PAR30 - 75W / BR40 90W Max.,
Non IC: BR40/PAR38 - 150W Max.



TM48RL
6" Super Slope Reflector
IC: BR/PAR30 - 75W / BR40 90W Max.,
Non IC: BR40/PAR38 - 150W Max.

4 & 6" CANS SEE COMPATIBLE CAN & TRIM OPTIONS BELOW.

4" LED READY HOUSING



ICL4ATQ



ICL4RATQ

COMPATIBLE TRIMS FOR 4" LED READY HOUSING (ICL4ATQ, ICL4RATQ)



TRR4RF-5CCTA
4" 5CCT Selectable LED Retrofit
Suitable for IC and Non-IC housings.



TRR4SQRF-X
4" Square LED Retrofit
Suitable for IC and Non-IC housings.



IC4RF-X
4" IC Rated Retrofit
This unit can only be considered IC rated if used in approved IC rated housing.

6" LED READY HOUSING



ICL6ATQ



ICL6RATQ

COMPATIBLE TRIMS FOR 6" LED READY HOUSING (ICL6ATQ, ICL6RATQ)



TRR56RF-5CCTA
5/6" 5CCT Selectable LED Retrofit
Suitable for IC and Non-IC housings.



TRR56SQRF-X
5/6" Square LED Retrofit
Suitable for IC and Non-IC housings.



IC56RF-X
5-6" IC Rated Retrofit
This unit can only be considered IC rated if used in approved IC rated housing.

NEW GENERATION CCT SELECTABLE LED RETROFIT

Expand your options with the new TRRRF Series. Multi-volt and 5 CCT options make this a great retro-fit for most recessed can housing applications.

Multi-Volt Function
120v-277v

COLOR SELECTIVE

5CCT Switchable
27K/3K/35K/4K/5K

Higher Lumens
1000,1500lm

TRR4RF-5CCTA

These LED Retrofit Kits are compatible with most 4" recessed cans. TRR4RF-CCTA is designed with a white baffle construction and comes with a dimmable LED driver. Comes with 3 tension fin clips for installation. Suitable for IC and Non-IC housings.

SERIES	SIZE	TYPE	COLOR TEMP.
TRR	[4] : 4"	[RF] : Retrofit	[-5CCTA] : 27K/3K/35K/4K/5K

TRR56RF-5CCTA

These LED Retrofit Kits are compatible with most 5" and 6" recessed cans. The TRR56RF-5CCTA is designed with a white baffle construction, and comes with a dimmable LED driver. Comes with 2 torsion clips for installation. Suitable for IC and Non-IC housings.

SERIES	SIZE	TYPE	COLOR TEMP.
TRR	[56] : 6"	[RF] : Retrofit	[-5CCTA] : 27K/3K/35K/4K/5K

*E26 socket adapter included.



NEW GENERATION!

WATTAGE & COLOR SELECTABLE RETRO DOWNLIGHT

Available in 6 and 8 inch sizes



NEW GEN CH SERIES

NOW ENERGY STAR LISTED
IMPROVED PERFORMANCE



Properly replace commercial-grade recessed downlights with unbeatable longevity and energy efficiency of LED. The built-in spring clips hold onto drywall directly, allowing the CH series to be installed without a frame, making installation faster and more cost-effective.

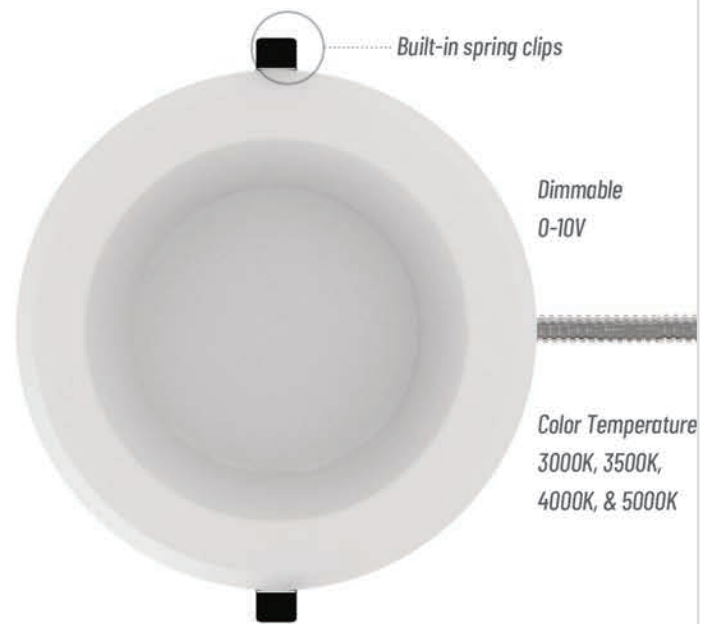

Built-in spring clips

Dimmable
0-10V

Color Temperature
3000K, 3500K,
4000K, & 5000K

EXAMPLE: CH-6-WSCS-WH-UZTD-G2

SERIES	SIZE	WATTAGE	COLOR TEMP.	FINISH	DIMMING
CH	[-6]: 6" [-8]: 8"	[-WS]: Wattage Selectable	[CS]: Color Selectable	[-WH]: White	[-UZTD-G2]: Dimmable, Gen2



JBD6-CS SERIES

COLOR SELECTABLE LED SURFACE MOUNT DISK LIGHT

JBD6-CS

JBD6-CS is a color selectable LED surface mount disk light made for mounting to electrical junction boxes.



Dimming - 10-100%

Internal CCT switch 27k/3k/35k/4k/5k

Example: JBD6-CS

SERIES	SIZE	COLOR TEMP
JBD	[6]: 6"	[CS]: 27K/30K/35K/40K/50K

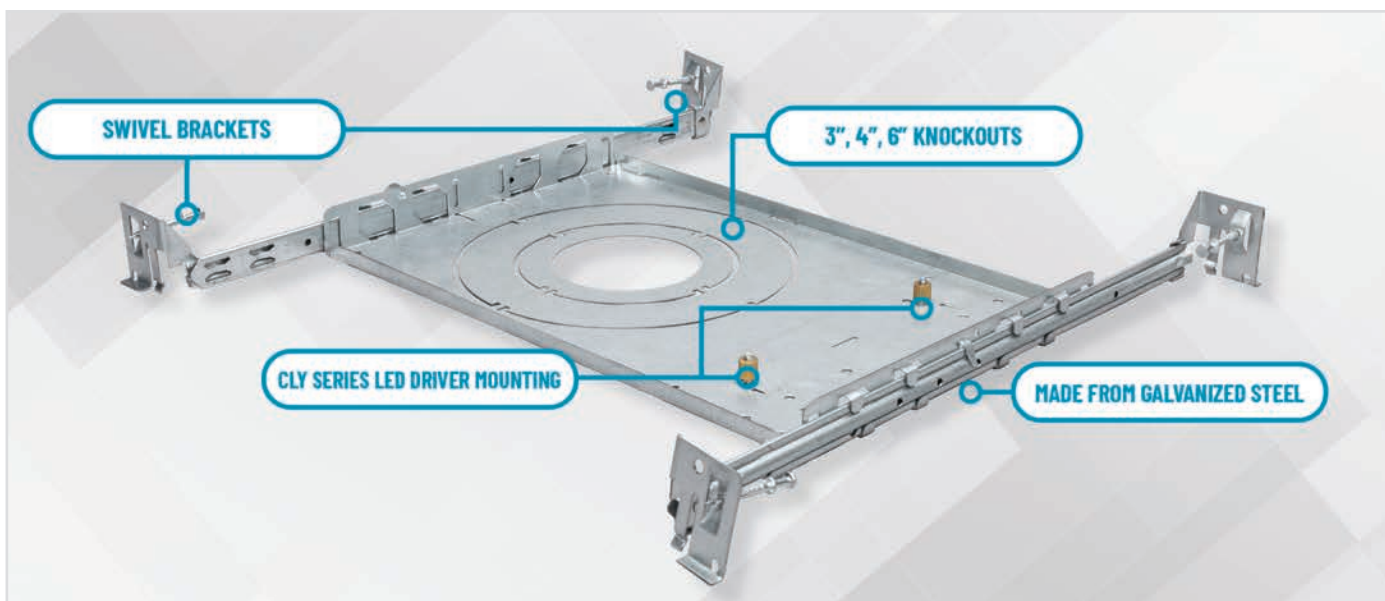

ALL-IN-ONE HANGER BRACKET ROUGH SERIES

ROUGH-HB

This All-In-One hanger bracket allows for easy installation of slim recessed downlights, now with the added advantage of mounting the driver directly to the bracket. Allows for use with 3", 4" and 6" slim disks using the appropriate knockout size on the hanger bracket.



Fits up to 24" spaced studs. Comes with double headed nails w/swivel and holding screws. Recommended for use with CLY series LED down lights.

PART NUMBER	STOCK CODE	DESCRIPTION
ROUGH-HB	0588-0324	ALL IN ONE ROUGH IN PLATE 3",4",6"

TRRMUC SERIES MINI UNDER CABINET LIGHT

Ideal for kitchens, closets, work benches, and more. This slim, low-profile fixture is ideal for task lighting. Available in 12", 20" and 40" lengths.



Accessories



FEATURES

- Linkable with accessories
- Low-profile
- Lightweight
- Easy-to-mount
- 50,000-hour life

Fixture

Part Number	Stock Code	Description	Color Temp.
TRRMUC1205WH	0542-5245	12" 5W Mini Under Cabinet White	3K
TRRMUC1205WH-4K	0549-5889	12" 5W Mini Under Cabinet White	4K
TRRMUC2008WH	0542-5248	20" 8W Mini Under Cabinet White	3K
TRRMUC2008WH-4K	0549-5901	20" 8W Mini Under Cabinet White	4K
TRRMUC4015WH	0542-5251	40" 15W Mini Under Cabinet White	3K
TRRMUC4015WH-4K	0549-5904	40" 15W Mini Under Cabinet White	4K

Accessories

Part Number	Stock Code	Description
TRRMUC-48WD	0542-8224	48W Driver
TRRMUC-AB	0542-8218	Adjustable Brackets
TRRMUC-BC	0542-8203	Butt Connector
TRRMUC-CC	0542-8227	1-Meter Connector Cable
TRRMUC-DS	0542-8221	Double Sensor
TRRMUC-FCC	0542-8206	Flat Corner Connector
TRRMUC-MS	0542-8212	Master Switch
TRRMUC-TD	0542-8209	Touch Dimmer

*Power supply and accessories sold separately.

PLUG & PLAY

UNDERCABINET LIGHTING

LED Slim Puck Lights fit almost any accent lighting application with easy plug-and-play connectivity.



TRRPL SERIES



Features

- Ideal for task lighting, cabinets, and display cases
- Durable aluminum die-casting with acrylic lens
- White aluminum with frosted acrylic lens
- Dimmable via optional in line dimmer

Ordering matrix

SERIES	COLOR TEMP.	FINISH
TRRPL	[30]: 3000K	[/WH]: White

Optional Accessories



TRRPL-PIR-SENSOR
PIR SENSOR FOR TRRPL PUCK LIGHT WHITE



TRRPL-DIMMER
IN LINE DIMMER FOR TRRPL PUCK LIGHT WHITE



TRRPL-36WD
36W 24V DRIVER FOR TRRPL PUCK LIGHT WHITE



TRRPL-4WAY
4 WAY SPLITTER WHITE



TRRPL-8WAY
8 WAY SPLITTER WHITE



TRRPL-CC
CONNECTOR CABLE FOR TRRPL SERIES PUCK LIGHT LENGTH: 40"



TRRPL-CCFM
MALE TO FEMALE CONNECTOR CABLE LENGTH: 40"

LEARN MORE
About Undercabinet Lighting



*Power supply and accessories sold separately.

TLVC SERIES

Low Voltage Dimmer/Driver in One



DIMMER/DRIVER IN ONE UNIT

1-100% DIMMING

5-YEAR WARRANTY

TLVC Series

A low voltage dimmer switch and LED driver integrated into one unit. The TLVC accepts 120v and converts it to 12 VDC or 24 VDC. White face plate included.

Ordering Information

EXAMPLE: TLVC60W-12

SERIES	WATTAGE	VOLTAGE
TLVC	60W	-12
TLVC	60W	-24



Recommended for use with TAMLITE CSRT LED Ribbon Tape.

RGBW RIBBON TAPE

TRRRT RGBW 24v

16' LED Ribbon Tape Kit RGBW

Features

- Dimmable with controller
- 16-foot length
- Available in wet or dry location options
- Linkable up to 32 feet using one 24V 70W driver
- 1-year limited warranty



Applications

Since the TRRRT RGBW 24v is available in wet/dry location options, this makes it great for residential, commercial, under cabinets, showcases, and cove lighting.



TRRRT 16FT KITS

Ordering Information

EXAMPLE: TRRRT16KIT-RGBNW-WET

SERIES	COLOR KITS	COLOR TEMP	LOCATION
TRRRT16KIT	[-RGB]: COLOR CHANGE	[WW]: 3000K [NW]: 4000K	[BLANK]: DRY IP20 [-WET]: WET IP65 *

Wet Locaton* -Wet Series only

TRRRT 16FT REELS

EXAMPLE: TRRRT16R-RGBNW

SERIES	16 FT REELS	COLOR TEMP	LOCATION
TRRRT16R	[-RGB]: COLOR CHANGE	[WW]: 3000K [NW]: 4000K	[BLANK]: DRY IP20 [-WET]: WET IP65 *

Wet Locaton* -Wet Series only



TRRRT RGBW 24v Accessories



TRRRT2SC
0549-5760
2' SPLICE CONN CBL 5 PIN



TRRRT6SC
0549-5763
6' SPLICE CONN CBL 5 PIN



TRRRT12SC
0549-5769
12' SPLICE CONN CBL 5 PIN



TRRRT24SC
0549-5772
24' SPLICE CONN CBL 5 PIN



TRRRT4FTSC
0549-5775
4FT SPLICE CONN CBL 5 PIN



TRRRT8FTSC
0549-5778
8FT SPLICE CONN CBL 5 PIN



TRRRTBSC
0549-5826
BUTT SPLICE CONN 5 PIN



TRRRT-2WAY
0549-5784
2 WAY SPLICE CONN CBL 5 PIN



TRRRT70WDRIVER
0549-5787
70W 24V DRIVER FOR TRRRT RGBW SERIES



TRRRT-BT
0549-5796
BLUE TOOTH RECEIVER/REMOTE FOR TRRRT SERIES



TRRRT-RF
0549-5805
RF RECEIVER AND REMOTE FOR TRRRT SERIES



TRRRT-ALEXA CONTROL
0549-5799
ALEXA CONTROL FOR TRRRT SERIES



TRRRT & TRRRL SERIES

TRRRT-120V RIBBON & TRRRL ROPE LIGHTS



TRRRT-120V Series

The TRRRT series is an expandable IP65-rated LED Tape light for outdoor and wet location jobs. Available in 13', 49', and 164' lengths with expansion capabilities to 164'. The TRRRT series is extremely versatile.

Features

- Flexible allowing for multiple applications
- Wet Location Rated
- TRRRT - Linkable up to 164ft
- TRRRT RGB - Linkable up to 156ft

TRRRT Series (Tape Light)
Cool White (5500k)
Warm White (2700k)

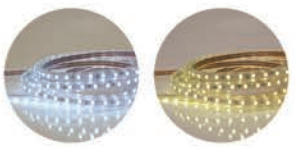

TRRRT RGB Series

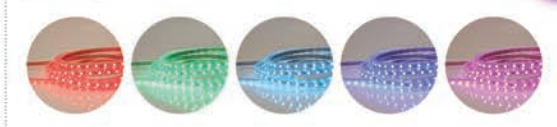

TRRRL Series

The TRRRL series is an expandable IP65-rated LED rope light for outdoor and wet location jobs. Available in 12', 48', and 150' lengths with expansion capabilities to 150'. The TRRRL series is extremely versatile.

Features

- Flexible allowing for multiple applications
- Wet Location Rated
- TRRRL - Linkable up to 150ft
- TRRRL RGB - Linkable up to 96ft

TRRRL Series (Rope Light)
Cool White (6500k)
Warm White (2700k)

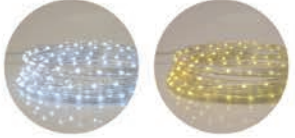

TRRRL RGB Series (Rope Light)

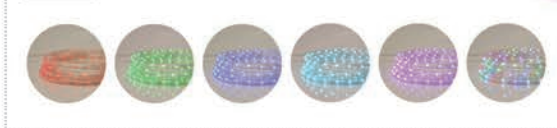

120V TRRRT RIBBON & TRRRL ROPE LIGHTS

TRRRL Series (Rope Light - Cool/Warm White)

PART NUMBER	STOCK CODE	DESCRIPTION
TRRRL-120V-12FT-CW	0551-4762	LED ROPE LIGHT 120V 12FT COOL WHT
TRRRL-120V-48FT-CW	0551-4765	LED ROPE LIGHT 120V 48FT COOL WHT
TRRRL-120V-48FT-WW	0551-4766	LED ROPE LIGHT 120V 48FT WARM WHT
TRRRL-120V-150FT-CW	0551-4768	LED ROPE LIGHT 120V 150FT COOL WHT
TRRRL-120V-150FT-WW	0551-4769	LED ROPE LIGHT 120V 150FT WARM WHT

TRRRL RGB Series (Rope Light - Color Selectable)

PART NUMBER	STOCK CODE	DESCRIPTION
TRRRL-120V-48FT-RGB	0551-4774	LED ROPE LIGHT 120V 48FT RGB
TRRRL-120V-96FT-RGB	0551-4777	LED ROPE LIGHT 120V 96FT RGB

TRRRT Series (Tape Light - Cool/Warm White)

PART NUMBER	STOCK CODE	DESCRIPTION
TRRRT-120V-13FT-CW	0551-4789	LED RIBBON TAPE 120V 13FT COOL WHT
TRRRT-120V-13FT-WW	0551-4780	LED RIBBON TAPE 120V 13FT WARM WHT
TRRRT-120V-49FT-CW	0551-4792	LED RIBBON TAPE 120V 49FT COOL WHT
TRRRT-120V-49FT-WW	0551-4783	LED RIBBON TAPE 120V 49FT WARM WHT
TRRRT-120V-164FT-CW	0551-4795	LED RIBBON TAPE 120V 164FT COOL WHT
TRRRT-120V-164FT-WW	0551-4786	LED RIBBON TAPE 120V 164FT WARM WHT

TRRRT RGB Series (Tape Light - Color Selectable)

PART NUMBER	STOCK CODE	DESCRIPTION
TRRRT-120V-13FT-RGB	0551-4798	LED RIBBON TAPE 120V 13FT RGB
TRRRT-120V-49FT-RGB	0551-4801	LED RIBBON TAPE 120V 49FT RGB
TRRRT-120V-164FT-RGB	0551-4804	LED RIBBON TAPE 120V 164FT RGB



CHRG SERIES YOKE MOUNT NOW INCLUDED!



CHRG Series

Electrify your flood application with the versatile field adjustable wattage/color selectable CHRG floods. With this knuckle/yoke flood going up to 80 watts, as well as the option to field adjust wattage, color temp, and a photocell, you can charge into any job knowing you have what you need with the CHRG series.



Versatile ALL-IN-ONE Flood

The yoke mount is now included in the box for the **CHRG25 WSCSBZK, CHRG60 WSCSBZK, & CHRG80 WSCSBZK.**

PART NUMBER	STOCK CODE	DESCRIPTION
CHRG25 WSCSBZK	0583-7661	FLD 25W WS CCT 120-277V BZ KNUCKLE/YOKE
CHRG60 WSCSBZK	0583-7667	FLD 60W WS CCT 120-277V BZ KNUCKLE/YOKE
CHRG80 WSCSBZK	0583-7670	FLD 80W WS CCT 120-277V BZ KNUCKLE/YOKE

RGBW Flood BRINGING COLOR TO THE OUTDOORS

These dimmable Bluetooth RGBW Floodlights are the perfect fixture for residential and commercial properties.



Features

- Bluetooth wireless connection
- 16 different colors of lights available
- 4 Modes: Scenes include flash, strobe, fade, and smooth
- Memory function recalls the color of your last setting
- High-quality durable housing with rugged aluminum case cover and efficient cooling structure



Phone App

- Link multiple units together in App
- Phone App controls colors



Ordering information

Example: TCOFLRGBW572BK-60

SERIES	COLOR TEMP	WATTAGE	FINISH	BEAM ANGLE
TCOFLRGBW	[5] : 5K	[30] : 30W [72] : 72W	[BK] : Black	[-60] : 60°

*Mesh gateway required for certain features. Contact factory for details.

BLST SERIES

The BLST bullet flood offers a knuckle mounting system and an adjustable beam angle for your lighting applications. Add this field adjustable, color selectable, and wattage selectable fixture to your landscape range for a clean, discreet look.

APPLICATIONS

With its adjustable beam angle, the BLST series is great for illuminating trees and shrubs, accenting gardens, retaining walls, fences, buildings, and more.



FIELD ADJUSTABLE

WS CCT PC

THIS UNIT IS DESIGNED WITH SELECTOR SWITCHES FOR WATTAGE, COLOR TEMPERATURE, AND PHOTOCELL.



EXAMPLE: BLST1 WSCS BZK

SERIES	WATTAGE	COLOR TEMP.	FINISH	MOUNTING
BLST	[1WS]: 5/10/15W	[CS]: 3K/4K/5K	[BZ]: Bronze	[K]: Knuckle
	[2WS]: 10/20/30W			



WALL CYLINDER SHN SERIES



FIELD ADJUSTABLE

WS CCT PC

THIS UNIT IS DESIGNED WITH SELECTOR SWITCHES FOR WATTAGE, COLOR TEMPERATURE, AND PHOTOCELL.

WSCS MODELS ONLY

SHN Series

Shine bright with the new Tamlite SHN series wall cylinder. A stylish architectural wall-mount luminaire that is ideal for accent lighting on building facades along walkways or near building entrances. Some typical installations include hotels, theaters, and restaurants.

SHN Series is also offered in 20W RGBW Color Selectable. Available in Double Ended Only.



EXAMPLE: SHN2 WSCS BZ 60/60

SERIES	CONFIGURATION	WATTAGE	COLOR TEMP.	FINISH	PRIMARY REFLECTOR	SECONDARY REFLECTOR*
SHN	[1]: Single Ended	[WS]: Wattage Selectable 10/20/30W	[CS]: Color Selectable 3K/4K/5K	[BZ]: Bronze	[15]: 15 Degree	[15]: 15 Degree
	[2]: Double Ended				[32]: 32 Degree	[32]: 32 Degree
					[60]: 60 Degree	[60]: 60 Degree

*Applicable to double ended models only.



EXAMPLE: SHN2 RGBW BZ 60

SERIES	CONFIGURATION	WATTAGE	FINISH	PRIMARY REFLECTOR
SHN	[2]: Double Ended	[RGBW]: 20W RGBW Color Selectable	[BZ]: Bronze	[60]: 60 Degree





OUTDOOR SECURITY LIGHTS

CMS Series

The CMS2 series of security lights deliver an energy-efficient way to provide safety and security to your home. Available in a two head security light, two head security light w/ motion sensor, & separate outdoor motion detector.



CMS180
ALSO AVAILABLE IN WHITE



CMS2
ALSO AVAILABLE IN WHITE



CMS2180
ALSO AVAILABLE IN WHITE



PART NUMBER	STOCK CODE	DESCRIPTION
CMS180BZ	0542-0031	180 DEGREE MOTION SENSOR ONLY BRONZE
CMS180WH	0542-0028	180 DEGREE MOTION SENSOR ONLY WHITE
CMS2BZ	0542-0010	LED SECURITY LIGHT 2 HEAD ONLY BZ 4K
CMS2WH	0542-0007	LED SECURITY LIGHT 2 HEAD ONLY WH 4K
CMS2180BZ	0541-9995	LED SECURITY LIGHT W/180DEG MOTION BZ 4K
CMS2180WH	0541-9974	LED SECURITY LIGHT W/180DEG MOTION WH 4K

TRRMSCS2180 Series

The TRRMSCS2180 series of security lights deliver an energy-efficient way to provide safety and security to your home. LED security floodlights are ideal for entrances, walkways, yards, driveways, and patios.



TRRMSCS2180
ALSO AVAILABLE IN WHITE



PART NUMBER	STOCK CODE	DESCRIPTION
TRRMSCS2180BZ	0542-0037	LED SECURITY LIGHT CCT 3K/4K/5K W/180DEG BZ
TRRMSCS2180WH	0542-0034	LED SECURITY LIGHT CCT 3K/4K/5K W/180DEG WH

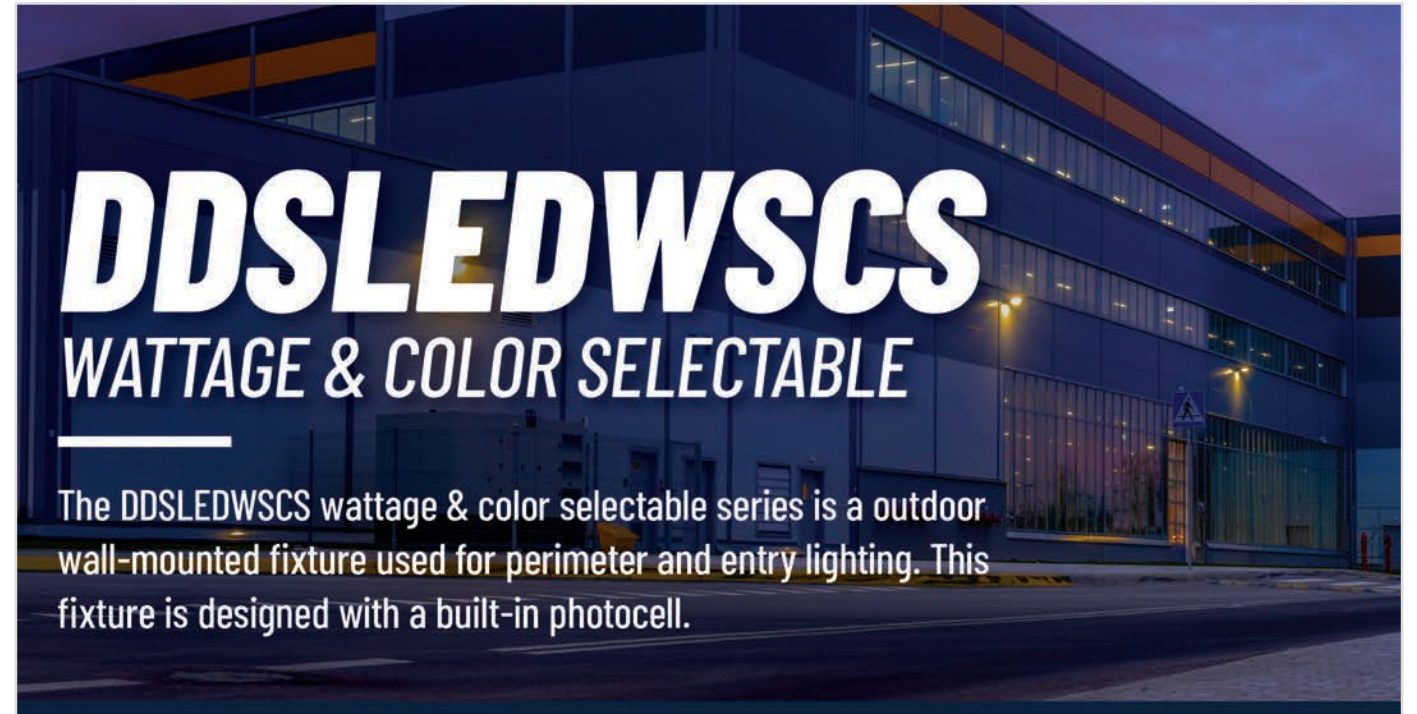

DDSLEDWSCS

WATTAGE & COLOR SELECTABLE

The DDSLEDWSCS wattage & color selectable series is an outdoor wall-mounted fixture used for perimeter and entry lighting. This fixture is designed with a built-in photocell.

Dusk-to-Dawn

This fixture is an excellent choice where an economical, dependable light source with dusk-to-dawn operation is desired.



Features

Intended Use

Outdoor wall-mounted fixture used for perimeter and entry lighting.

Photocell

Fixture is designed with built-in photocell.

Optics

Precision molded polycarbonate optical lens is engineered for superior light area distribution.

Wattage/Color Selectable

The DDSLEDWSCS is also wattage and color selectable.



Example: DDSLEDWSCS

SERIES	WATTAGE	COLOR TEMP.	BODY COLOR
DDSLED	[WS] : Selectable 30W/40W/50W	[CS] : Selectable 3000K/4000K/5000K	[Blank] : Grey

*Mount arm included

STRK SERIES LED AREA/ FLOOD LIGHT

The STRK series is a versatile LED area/flood light that is customizable in many ways. This series has many mounting, optic distribution, and sensor options.



Example: STRK805K T2 U SF BZ HSS

SERIES	WATTAGE	COLOR TEMP	DISTRIBUTION	VOLTAGE	MOUNTING	FINISH	OPTIONS
STRK	[80] : 80W* [150] : 150W [230] : 230W [300] : 300W [400] : 400W	[3K] : 3000K [4K] : 4000K [5K] : 5000K	[T2] : Type 2 [T3] : Type 3 [T4] : Type 4 [T5] : Type 5	[U] : 120-277V* [E] : 277-480V	[BLANK] : No Mounting [TR] : Trunnion [SP] : Square Pole Arm [RP] : Round Pole Arm [SF] : Slipfitter	[BZ] : Bronze	[BLANK] : 3 pin TL** [HSS] : House Side Shield*** [MS] : Microwave motion sensor**** [USA] : Assembled in USA

Microwave sensor can only be used with 120-277v options.* 80w option only available in 120-277v.* Does not come with the 3 pin twist lock photocell, only the receptacle.** Does not meet DLC when installed.***

STRK SERIES ACCESSORIES

Sold separately



POLE MOUNT
STRK PASF BZ
0582-9201



WALL MOUNT
STRK WM BZ
0582-9198



EXTERNAL GLARE SHIELD
STRK GLARE SM BZ (80-150W)
0582-9249

STRK GLARE LG BZ (230-300W)
0582-9255



HOUSE SIDE SHIELD
STRK HSS SM (80-150W)
0582-9219

STRK HSS LG (230-300W)
0582-9243



SPOKE BRACKETS





TCOSB1BZ
SINGLE ARM
TENON BRACKET



TCOSB2180BZ
2 SPOKE TENON
BRACKET @ 180



TCOSB290BZ
2 SPOKE TENON
BRACKET @ 90



TCOSB3120BZ
3 SPOKE TENON
BRACKET @ 120



TCOSB390BZ
3 SPOKE TENON
BRACKET @ 90



TCOSB490BZ
4 SPOKE TENON
BRACKET @ 90

Wattage and Color Selectable

W2LEDWSCS SERIES LED WALL PACK

The W2LEDWSCS wall pack switches between color temperature and wattage, making your lighting configuration possibilities endless. This LED wall pack is best suited for outdoor applications, such as facade, parking garage, and walkway lighting.

FIELD ADJUSTABLE

WS CCT PC

THIS UNIT IS DESIGNED WITH SELECTOR SWITCHES FOR WATTAGE, COLOR TEMPERATURE, AND PHOTOCELL



- Features:**
- Wattage Selectable: 50W/60W/80W
 - Color Selectable: 3000K/4000K/5000K
 - Three 1/2" Coin plugs with O-rings
 - Corrosion-resistant stainless steel hardware
 - Durable bronze or white powder-coat finish
 - Integrated photocell with ON/OFF switch



W2LED is also available in white color option.



Accessories
* Sold Separately



W2 VISOR
0544-4430

W2 VISOR WH
0547-9260

SERIES	WATTAGE	COLOR TEMP	BODY COLOR
W2LED	[WS] : SELECTABLE 50W/60W/80W	[CS] : Selectable 3000K/4000K/5000K	[BLANK] : Bronze [WH] : White

FIELD ADJUSTABLE MINI WALL PACK

MWPWSCS
SERIES

DIMMABLE
Dimmable Fixture: 0-10V



FIELD ADJUSTABLE

WS CCT PC

[WS]: 30W,20W,10W
[CS]: 3K,4K,5K



The mini wall pack is a great choice for both residential and commercial applications where a small, compact durable fixture is required.

MWPWSCS SERIES

The MWP field adjustable mini wallpack is a versatile wall pack packed with a 3-in-1 field adjustable switch. The fixture is wattage and color selectable. The fixture also comes with a photocell control with a switch to turn on/off in the field.

Example: MWPWSCS

SERIES	WATTAGE	COLOR TEMP
MWP	[WS]: 30W,20W,10W	[CS]: 3K,4K,5K



LIGHT THE WAY



ESRD BREM CS SERIES

The ESRD-BREM-CS is an architectural LED emergency wall pack. It features an integrated photocell and adjustable color temperature, making it ideal for numerous applications.



FEATURES

- Self-Test and Self-Diagnostic
- IP65 rated for use in wet locations
- Cold weather rated to -30°C
- 5-year limited warranty
- Integrated photocell

EXAMPLE: ESRD BREM CS

SERIES	HOUSING COLOR	OPERATION	COLOR TEMPERATURE
ESRD	[BR]: Bronze	[EM]: Emergency Backup	[CS]: Color Selectable 3K/4K/5K

LXP SERIES



- Discharge Time: 90 Minutes (1.5 Hours)
- Operating Voltage: 120/277VAC
- LED Red or Green letter

Slim Series Color Selectable LED Exit Sign

LXP SERIES

Slim thermoplastic LED exit sign offers a modern look with long lamp life, energy efficiency and uniform illumination; all components feature a snap-fit construction for speed and ease of installation.



Example: LXP3MWEM-CS

SERIES	NO. OF FACES	LETTER COLOR	HOUSING COLOR	BATTERY	STANDARD
LXP	[3]: Universal Single and Double Face	[M]: Multicolor (Green and Red)	[W]: White	[EM]: Battery Backup	[-CS]: Color Selectable

BE PREPARED FOR WHEN EMERGENCY STRIKES



LXPC-CS SERIES

The LXPC series thermoplastic LED exit sign and emergency lighting combination unit offers long lamp life, energy efficiency, and uniform illumination with round LED light heads.

FEATURES

- Discharge Time: 90 Minutes (1.5 Hours)
- Operating Voltage: 120/277VAC
- Battery Type: EFB-NIC-3.6V-900

Example: LXPC3MWEM-CS

SERIES	NO. OF FACES	LETTER COLOR	HOUSING COLOR	BATTERY	STANDARD
LXPC	[3]: Universal Single and Double Face	[M]: Multicolor (Green and Red)	[W]: White	[EM]: Battery Backup	[-CS]: Color Selectable



WHEN THE LIGHTS GO OUT



LET THE MSR SERIES GUIDE THE WAY TO SAFETY

MSR SERIES

Mini Wet Location Impact Resistant LED

The MSR-LED-WP is an adjustable micro wet location thermoplastic LED emergency light.

- Recharge Time: 24 Hours
- Discharge Time: 90 Minutes (1.5 Hours)
- Lumen Output: 118 Lumens per Head
- Operating Voltage: 120/277VAC



PART NUMBER	STOCK CODE	DESCRIPTION
MSR-LED-WP	0371-9739	MINI IMPACT RESISTANT, WET LOCATION LED EMERGENCY LIGHT

LC-WL SERIES WIRELESS LIGHTING CONTROLS

Your wireless lighting solution is here! Bluetooth lighting controls - when paired with LED technology, provides maximum energy savings potential. Control multiple lighting applications with your mobile phone. Scan the QR code to download the App today!

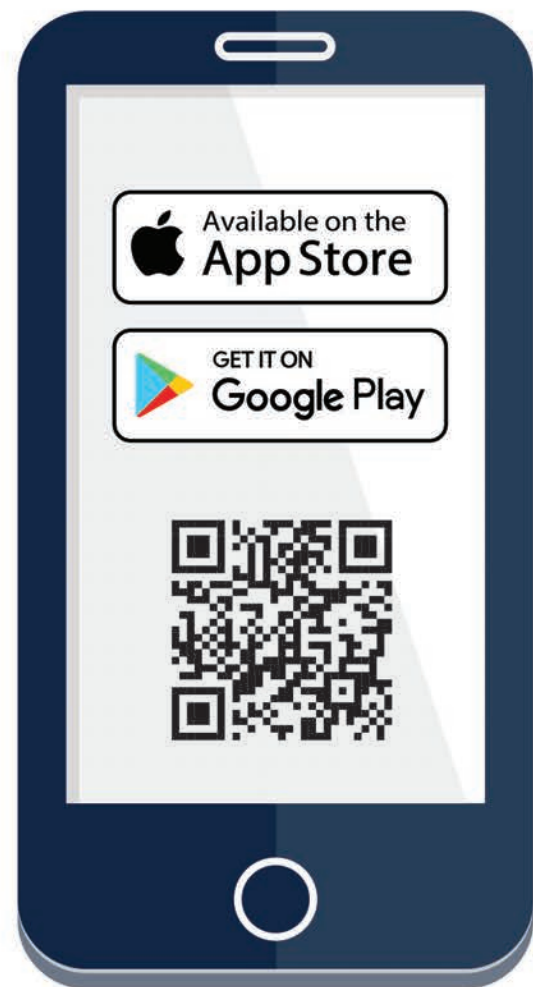

- Daylight Harvesting** - Automatically dim lights when enough daylight is present. This can save 10 to 60 percent in electricity costs.
- Time Clock Scheduling** - Automatically dim or turn lights off at select times of the day. Reduce electricity costs by 10% to 35% by ensuring lights are not wasting energy when they are not needed.
- High-End Trim** - All spaces do not need the full brightness of their light fixtures. For example, the human eye notices only a small difference between 100% and 80% brightness, and the electricity usage and cost can be reduced by 20% or more.
- Occupancy Sensing** - Occupancy sensors automatically turn off or dim due to the lack of movement in a space. Bluetooth wireless technology allows sensors to be installed in minutes with no additional wiring. These are also ideal solutions for retrofit applications. Sensors can reduce lighting/ electricity use from 15% to 60%.
- Personal Control** - This allows individuals to control the full range of light dimming directly over their workstations. This often results in energy savings of 10% or more, while improving productivity, reducing eye strain, and computer glare.

SEE FULL LINE OF WIRELESS CONTROLS ON NEXT PAGE

WIRELESS LIGHTING CONTROLS

Wireless Controls - Bluetooth



LC-WL-BT01 • 0554-6403
BLUETOOTH MESH POWER PACK



LC-WL-BT02 • 0554-6412
BLUETOOTH WIRELESS WALL SWITCH



LC-WL-BT03 • 0554-6418
PREMIUM BT MESH POWER PACK/SENSOR



LC-WL-BT04 • 0554-6424
OC SENSOR FOR LC-WL-BT01

Wireless Controls - EnOcean 902MHZ



LC-WL-E901 • 0581-1972
0-10V 5A FIXTURE
CONTROLLER, 100-277VAC



LC-WL-E902 • 0581-1975
SINGLE ROCKER
DECORATOR STYLE



LC-WL-E903 • 0581-1978
DUAL ROCKER
DECORATOR STYLE



LC-WL-E905 • 0581-2002
MOTION DETECTOR WITH
ILLUMINATION SENSOR



LC-WL-E906 • 0581-2005
8-CHANNEL LOW VOLTAGE RELAY
RECEIVER



LC-WL-E908 • 0581-2011
600W PHASE CUT DIMMER:
ER6CD-AU-120



LC-WL-E909 • 0581-2014
CONSTANT VOLTAGE LED
DIMMER WITH FLYING



LC-WL-E910 • 0582-5433
0-10V 20A AREA CONTROLLER,
100-277VAC



LC-WL-E912 • 0583-2843
USB ENOCEAN GATEWAY
902MHZ

CHECK OUT OUR WEBSITE FOR MORE INFORMATION - WWW.TAMLITEUSA.COM

TAMLITE[®]

LIGHTING



TAMCO CUSTOMER SERVICE

772.878.4944



TECHNICAL SUPPORT

TAMLITE LIGHTING

info@tamliteusa.com



GET A QUOTE

quotes@tamcogroup.com

CES BRANCH USE

TAMCO
11675 SW TOM MACKIE BLVD,
PORT ST. LUCIE, FL
34987

t. 772.878.4944

customer.service@tamcogroup.com
www.tamcogroup.com
tamliteusa.com

© 2023 Tamco Group | All Rights Reserved

